

# CURTAIN TRACKS CEILING PANEL ROOM DIVIDER

SYSTEMS | CURTAIN TRACKS

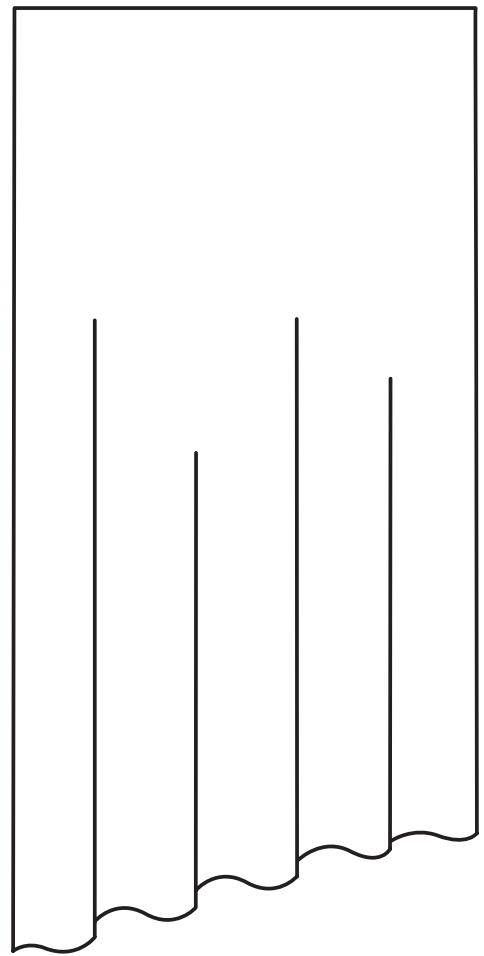

*création* **baumann**  
systems



# CEILING PANEL ROOM DIVIDER TECHNIC

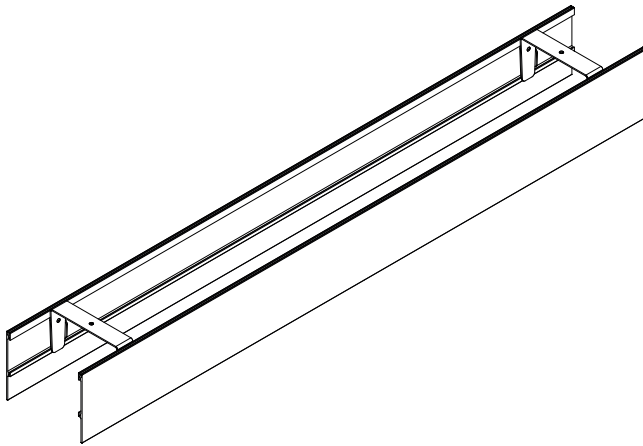
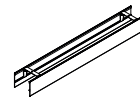

## Profile

Plain extruded aluminium profile for room partition systems, to hide the curtain track.  
As a visual enhancement and to optimise sound insulation for acoustically effective curtains.

- For straight installations
- Always used in combination with curtain tracks
- Mainly used in the contract business

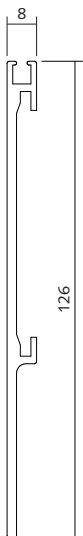

## Colour

Standard white RAL 9016  
Standard grey RAL 9006  
Standard black RAL 9005  
Other colours on request

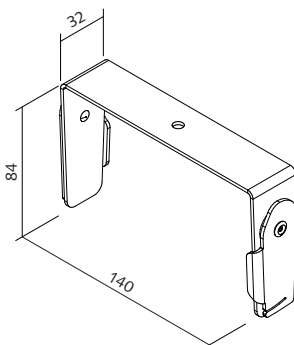

## Profile holder

U-shaped metal bracket with tension lever on the left and right side for attaching the ceiling panel, powder coated and riveted.

## Colour

Standard white RAL 9016  
Standard grey RAL 9006  
Standard black RAL 9005  
Other colours on request

# CEILING PANEL ROOM DIVIDER INSTALLATION

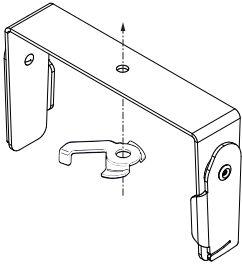
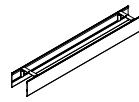

Position  
tension jack

Follow the distances according to the specifications of the respective curtain rail.  
(Position the profile holder between tension jack and ceiling).

For the use of additional tension jacks in between of two profile holder, place a 2 mm thick spacer washer underneath, to compensate the height difference.

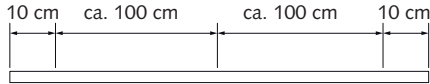

Position  
profile holder

Place profile holder at a distance of approx. 100 cm.

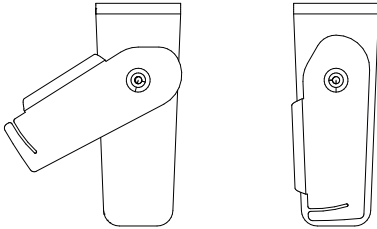

Profile holder  
with tension lever

Left illustration: Tension lever open, basic position for mounting the ceiling panel.

Right illustration: Tension lever closed, for attaching the ceiling panel.

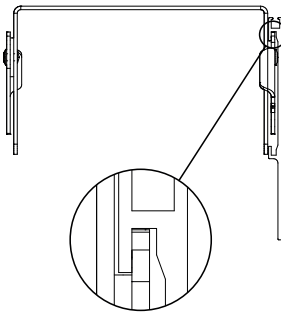
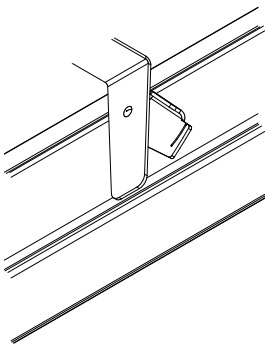

Procedure:

- Fix the profile holder to the ceiling by placing it between ceiling and tension jack.
- Move all tension levers to the open position.
- Place the hook of the ceiling panel over the tension lever.
- Align the panel sideways.
- Close the tension lever (turn it downwards) and thereby secure the ceiling panel.

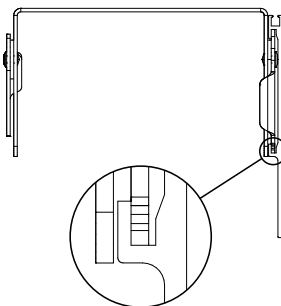
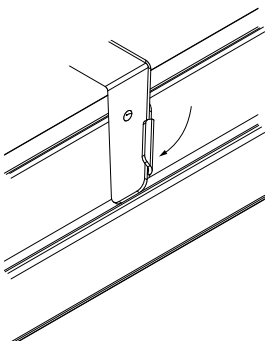

# CEILING PANEL ROOM DIVIDER INSTALLATION

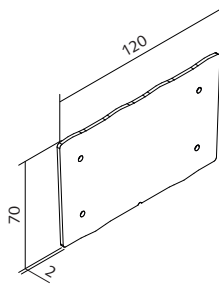
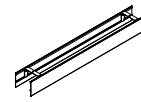

Connector Powder-coated metal plate with four grup screws.

Colour Standard white RAL 9016  
Standard grey RAL 9006  
Standard black RAL 9005  
Other colours on request

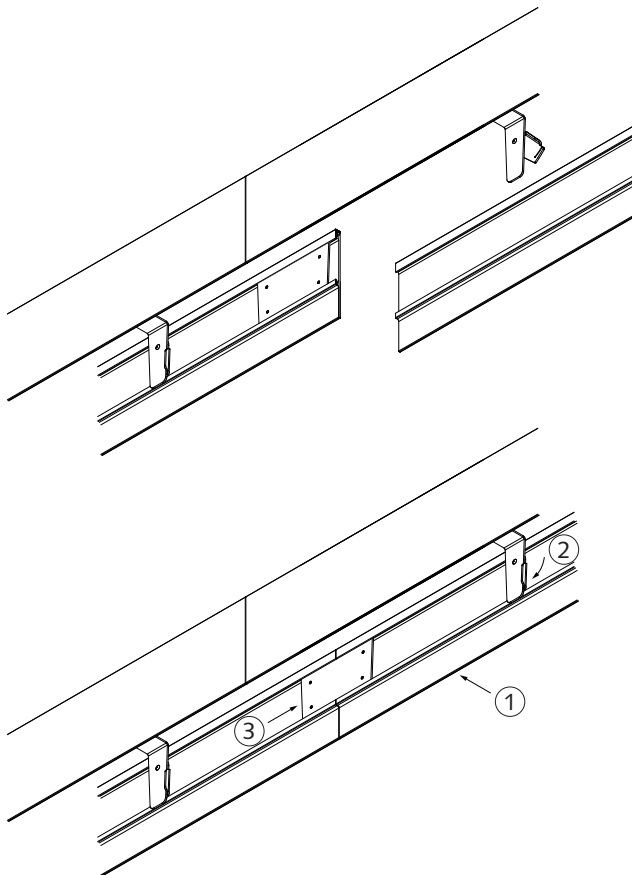

Procedure for butt joint:

- Mount, align and secure the first ceiling panel.
- Push the profile connector completely onto the panel at the connection point.
- Place the connecting panel over the tension levers by means of the hooks (1).
- Align the panel laterally flush with the already fixed profile.
- Close the tension lever on the side of the connecting panel (turn downwards) to secure the ceiling panel (2).
- Push the profile connector halfway into the connection panel and fix the position with the grup screws (3).

## CEILING PANEL ROOM DIVIDER ACCESSORIES

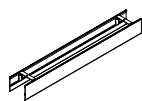

Sealing profile

Elastic profile made of silicone to prevent sound bridges directly along the ceiling.

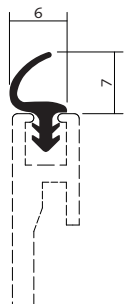



Our comprehensive range and a complete list of our global sales outlets can be found at [www.creationbaumann.com](http://www.creationbaumann.com).

10/2021

Création Baumann AG  
Bern-Zürich-Strasse 23 | CH-4901 Langenthal  
telephone +41 (0)62 919 62 69 | fax +41 (0)62 919 62 65  
[mail@creationbaumann.com](mailto:mail@creationbaumann.com) | [www.creationbaumann.com](http://www.creationbaumann.com)

*création* **baumann**  
systems